



Scan & Submit  
Your E-Warranty



Or Visit

<https://ikahome.com.my/ika-ewarranty>  
SCAN ME FOR E-WARRANTY REGISTRATION

**HOME TYPE TRADING SDN BHD**

LOT 1848-C, JALAN KPB 8, KG. BARU BALAKONG,  
43300 SERI KEMBANGAN,  
SELANGOR DARUL EHSAN, MALAYSIA.  
TEL: 03-8962 1848 FAX: 03-8961 8848

## User's Manual of Cooker hood

This Manual applies to Cooker hood

- Before operating, please read this Manual carefully, and keep it properly.
- The pictures in this Manual are for reference only.



## Foreword & Contents

### Foreword

“Beautiful life starts from your kitchen”. Thanks for purchasing Ika kitchen appliances. Ika kitchen appliances undertake the social mission to provide beautiful kitchen lives for mankind, and Ika is committed to becoming the best kitchen life solution supplier in the world. We adhere to the purpose of quality first and customer foremost. If you have any comments and suggestions, please don't hesitate to contact us, and we will provide perfect services according to your needs. Warning: Before installing and using, please read this Manual carefully, and get familiar with the safety precautions in order to use it properly. Note: The appearance and structure of our products are subject to change without prior notice.

### Contents

Foreword.....	1
Safety Precautions.....	2
Specification and Parameters.....	3
Packing list.....	3
Product Diagrams.....	4
Safety Instructions.....	5
Installation Method.....	6
Exhaust Pipe Installation.....	7
Electrical Schematic.....	7
Method of use.....	8
Method of use.....	9
Maintenance and Cleaning.....	10
Trouble Shooting.....	11

## Safety Precautions

1. This is an appliance designed for home use by adults.
2. The appliance must be installed by a skilled and qualified installer.
3. Keep electrical appliances out of reach from children. Donot let them operate the appliances without supervision.
4. Before installation, check if the main supply voltage is matched with the voltage of appliance.
5. To protect against the risk of electrical shock, do not immerse the appliance, cord or plug into water or any other from liquid.
6. The appliance and its filter should be cleaned regularly in order to keep in good working order.
7. Clean the appliance according to the instruction manual and keep the appliance from the danger of burning.
8. The room must be well-ventilated when using cooker hood together with other cooking appliances.
9. For any replacements or alterations that may be required to contact an authorized Technical Assistance Centre and insist on the use of original spare parts. No parts or components should be removed or replaced except by a qualified person.

### Important:

The manufacturer cannot be held responsible for damage to property or personal inquiry resulting from incorrect installation.

## Specifications and Parameters

Product Name	Cooker Hood	Cooker Hood
Model Number	IKA-KREFELD	IKA-KREFELD PLUS
Voltage	220V-240V	220V-240V
Frequency	50-60Hz	50-60Hz
Rated Power	233W	263W
Air Flow	1450m <sup>3</sup> /hr	1450m <sup>3</sup> /hr
Noise Level	60dB	60dB
Light Power	1X3W	1X3W
Auto Clean Power	—	60W

★ Note: Refer to the mark on the nameplate of the cooktop for the rated gas pressure.

## Packing list

NO.	Model Number	IKA-KREFELD	IKA-KREFELD PLUS
1	Cooker hood	1pc	1pc
2	Exhaust pipe	1pc	1pc
3	Hand strip	1pc	1pc
4	Oil collector	1pc	1pc
5	Instruction manual	1pc	1pc
6	Supporting bar for chimney cover	1pc	1pc
7	Self tapping screw	5pcs	5pcs
8	Expanded colloid	3pcs	3pcs
9	Expanded screw	5pcs	5pcs
10	Limit screw	/	/
11	Wood	4pcs	4pcs
12	Foam	1 set	1 set

## Product Diagrams

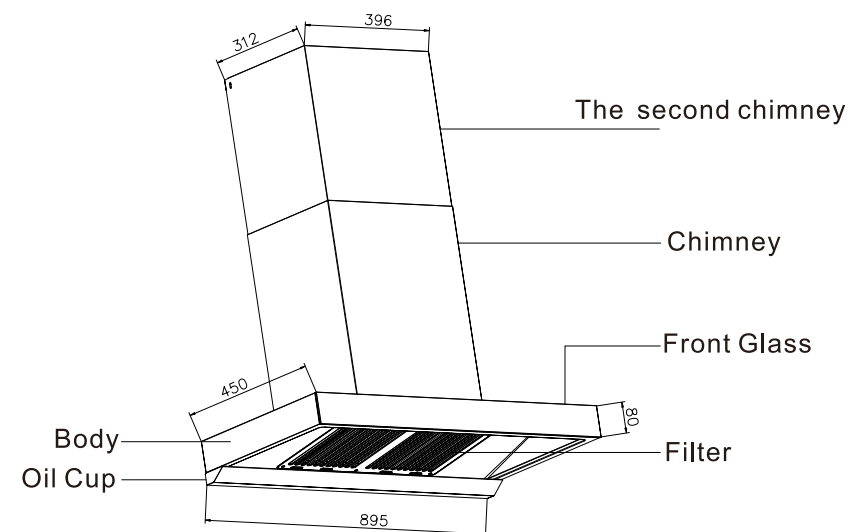

## Safety Instructions

Fig.1

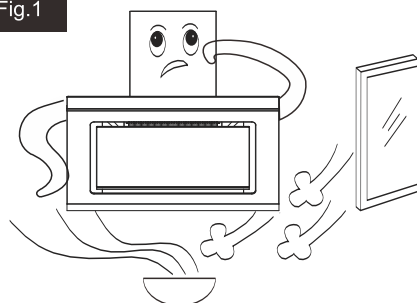

- ❑ Do not fix the hood so high, to prevent air flow from outside, which affect the efficiency.

Fig.2

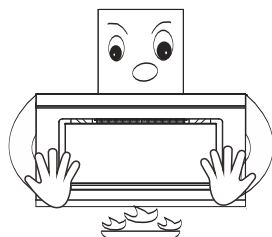

### Warning

- ❑ Do not burn the hood directly, to avoid damaging the hood and causing accidents.

Fig.3

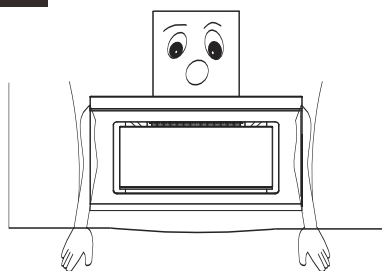

- ❑ Please keep an enough space for hood installing & dismantling; it is helpful for inspection and maintenance.

Fig.4

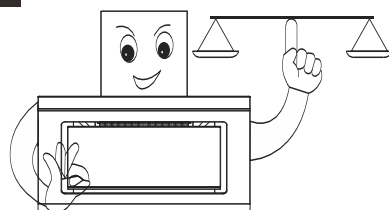

- ❑ Please keep the hood in balance while installing.

Fig.5

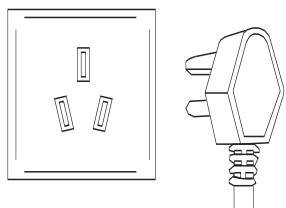

- ❑ Please use single-phase socket and it should be well connected with the grounding.

Fig.6



- ❑ Please install by a skilled and qualified installer.

## Installation Method

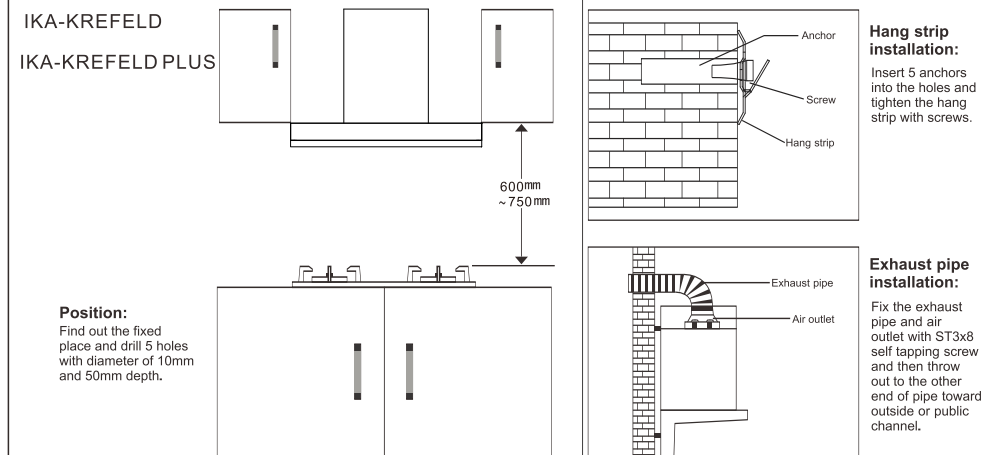

### Cooker Hood Installation:

Hand the cooker hood and make sure it is in level, and screw up cooker hood with hand strip toward the wall, to avoid falling down.



### Notice

- Make sure the exhaust pipe is not bending less than 90 degree.
- Do not connect with other pipe whose diameter is less than the rated size of exhaust pipe.
- Don't insert too deep if you want to connect pipe with the public one directly, to avoid increasing exhaust resistance.
- Do not discharge smoke from cooker hood into the hot chimney with smoke from burning gas or other fuels, to avoid fire accident.

## Exhaust Pipe Installation

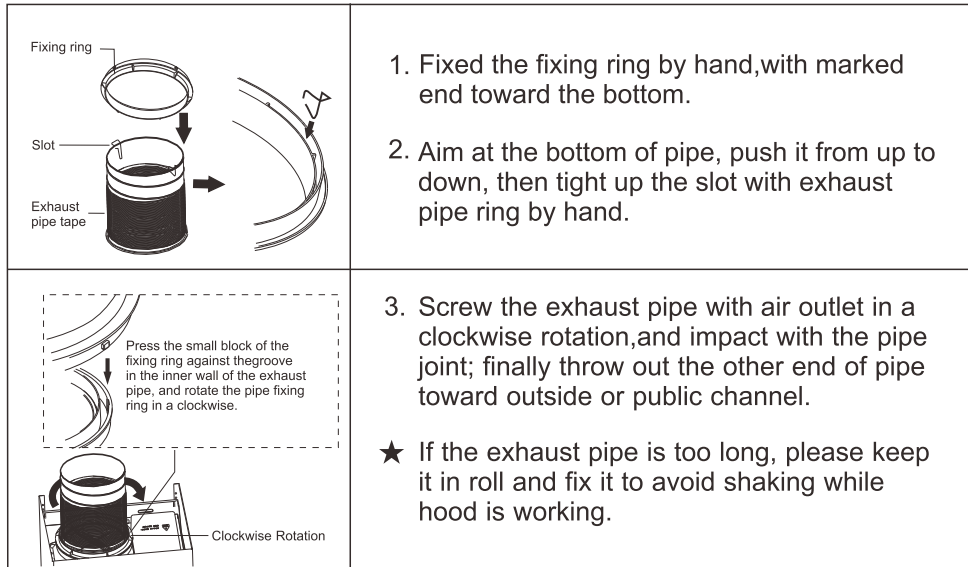

## Electrical Schematic

IKA-KREFELD

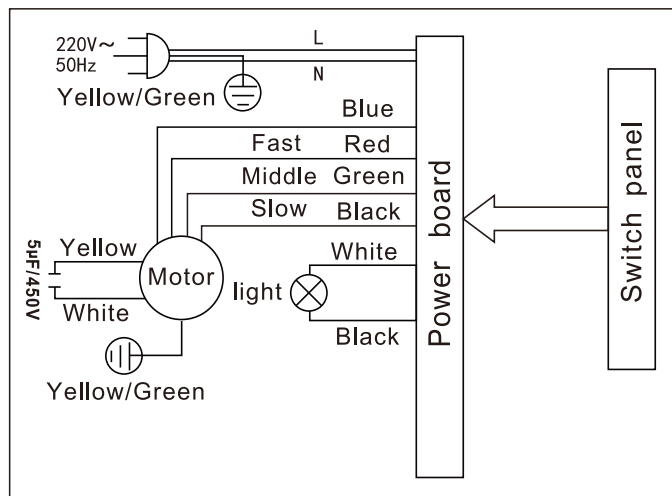

## Method of use

IKA-KREFELD



**Gesture On:** Connect power, system enter gesture standby state, when hand wave from left to right for first time, motor run in fast, for second time, run in medium, for third time run in slow, for the fourth time, motor stop running, wait other operation; Like this cycle.

**Gesture off:** When hand wave from right to left, motor stop running. Enter shutoff.

**Warmly tips:** Use gesture function, please make sure hand point at sensor area, the best interval is 2secs, the best distance is 8-15CM (With 5mm transparent glass).

**⏻ Switch/Delay:** Touch it when power off, enter standby. Touch it when motor is running, enter 1 minute delay. During delay touch it again, all functions are stopped. Enter shutdown. Touch it for 3 secs can on/off gesture function with sounds.

**⤴ Fast:** Touch it in standby, motor run in fast, touch it again, motor stop running enter standby state.

**⤵ Medium:** Touch it in standby, motor run in medium, touch it again, motor stop running enter standby state.

**⤶ Slow:** Touch it in standby, motor run in slow, touch it again, motor stop running enter standby state.

**★ Illumination:** Touch it to turn on /off light in any state.

## Method of use

IKA-KREFELD PLUS



**Gesture On:** Connect power ,system enter gesture standby state,when hand wave from left to right for first time ,motor run in slow ,for second time ,run in medium ,for third time run in fast ,for the forth time,motor run in slow ;Can cycle.

**Gesture off :**When hand wave from right to left ,motor stop running.Enter shutoff.

**Warmly tips:**Use gesture function ,please make sure hand point at sensor area,the best interval is 2secs ,the best distance is 8-15CM (With 5mm transparent glass) .

**Switch/Delay:** Touch it when power off ,enter standby.Touch it when motor is running ,enter 1 minute delay .During delay touch it again,all functions are stopped.Enter shutdown.Touch it for 3 secs can on/off gesture function with sounds.

**Fast/Medium:** Touch it in standby, motor run in medium, touch it again motor run in fast, touch it third time, enter standby state.

**Slow:** Touch it in standby ,motor run in slow ,touch it again ,motor stop running enter standby state.

**Auto Clean:** When the cooker hood is shut down, touch Heat cleaning to enter into cleaning mode. The indicator lamp of Thermal cleaning turned on.

### The cleaning cycle is as follows:

The cleaning mode works for 10 minutes and then the High speed works for 1 minute which marks the end of of the cleaning cycle. The cooker hood then shuts down, with all indicator lamps off. (In the clean state, only lamp, auto clean and power/delay button can be operated, the other buttons cannot be operated.)

**Illumination:** Touch it to turn on /off light in any state.

## Maintenance and Cleaning

- Pull out the electric plug before repairing and maintaining the cooker hood and clean according to the methods of Introduction, to avoid firing danger.
- Wear gloves when cleaning surfaces to prevent your hands being hurt by seamed edges.
- Don't use water to wash the cooker hood directly.
- The cooker hood should be maintained and cleaned regularly depending on the surrounding environment to keep its cleanness, a good effect and a longer service life.
- Timely cleaning when oil reached two thirds of oil collector , to avoid spilling.Fig. 15 for reference, to remove the oil collector.

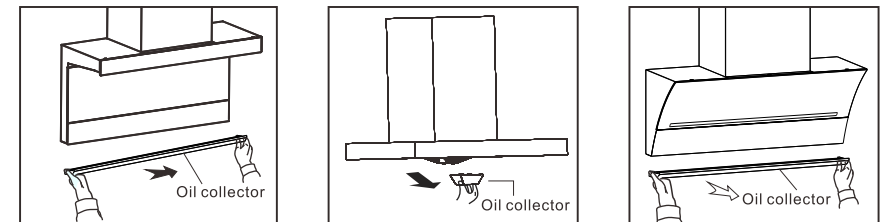

Fig.15

### Stainless Steel Surface Cleaning:

Use neutral detergent without abrasive to clean the surface, and do not clean with hard object or steel ball.

### Changing a Light:

You must pull off the electric plug before changing a light. Keep the power rate of light no more than 5.0W and you could check the power rate from label.

### Notice:

If your cooker hood occurred the following phenomena, you must unplug the power cord and contact with our service center:

- Irregular sound when opening the cooker hood.
- Abnormal phenomena or vibration when working.
- Finding unpleasant smell, smoke, heating and other unknown phenomena.

## Trouble Shooting

Fault	Cause	Solution
Touch any icon but no responses.	The plug is not or improperly inserted or no power supply.	Plug the power cord.
Touch light icon, but the light cannot turn on.	The light is damaged, poorly contacted with the power supply.	Use a good light or plug the power cord.
There is faradic electricity on the surfaces of the cooker hood with a slight electric shock.	The electric outlet is not effectively grounded.	Use one-way triple socket and have a good grounding.
Irregular sounds are heard when the impeller operates.	The impeller becomes loose and screws are not fixed.	Tighten up the screw of impeller.
Universal pipe with noise.	Universal pipe does not straightened.	Please install as required.
Oil dripping.	Installation of oil collector is not suitable.	Install correctly.

(For model IKA-NESTON, IKA-MUNICH and IKA-DRESDEN)

★ Activated Carbon for Option

If using activated carbon for IKA-NESTON, please take down the chimney cover, then put the buckle of activated carbon aiming to nut on the cabinet, push it in a counter-clockwise direction, till the carbon panel is fixed well.

