

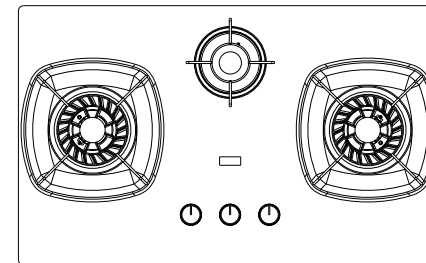

USER MANUAL



MODEL NUMBER:
IKA-LAVA3B-MB

HEAT
RESISTANT
TOUGHENED
8MM THICK
GLASS

DURABLE
JUMBO
BURNER

SMOOTHLY
OPERATING
KNOBS

STAINLESS
STEEL
DRIP TRAY

READ THIS MANUAL CAREFULLY BEFORE USING AND STORE IT IN A SAFE PLACE FOR FUTURE REFERENCE

Dear customer:

Thank you for purchasing our products. In order to ensure that you can use this appliance in the best way, please read this instruction manual carefully before use and keep it for future reference.



The manufacturer wishes to emphasize that it assumes no liability for damages incurred through failure to adhere to the prescribed guidelines or any unauthorized modifications to the appliance's components, as well as the utilization of non-genuine replacement parts.

CONTENT

SPECIAL PRECAUTIONS	1
PARTS IDENTIFICATION	3
INSTALLATION	4
DIRECTION FOR USE	5
PRODUCT DIMENSIONS	6
CLEANING AND MAINTENANCE	6
TROUBLE-SHOOTING GUIDE	7

1. SPECIAL PRECAUTIONS

To avoid any danger and loss when using the hob, we make below mark. Below is all about special precautions. Please pay full attention to it and operate in a right way.

■ Marks are identified by different danger and loss level

 **WARNING** If ignoring this mark and operate improperly, it may lead die, hurt or fire.

 **ATTENTION** If ignoring this mark and operate improperly, it may lead die, hurt or fire.

ADVICE In order to be safe and convenient when using it, please kindly understand this content.

■ Marks for ATTENTION

 BURNING	 MUST DO	 FORBIDDANCE	 NO FIRE	 NO TOUCH	 NO DISASSEMBLY
--	--	--	--	---	---

DANGER

 When gas leakage
1. stop using the hob immediately.
2. turn off the gas valve
3. open windows and doors
4. contact the local gas company



 If case of gas leakage
*do not ignite any fire.
*do not turn on any electrical appliance
*do not touch power plug
*do not use telephone nearby

Flame spark will lead fire.



 When feeling strange burning, or smell gas, or in case of earthquake, fire, please do as below:
1. turn the knob to OFF position
2. turn off the gas valve
3. contact our after-sale service dept. immediately

Above is to avoid fire or fault.

 Please use the right type of gas according to the rating label.

If use the gas other than that are appointed, it may leads gas cooker damage or even fire.

! To install, repair, move a gas appliance, must be carried out by our service dept., or a registered gas installer. Otherwise, we will not take the responsibility for any damage.

! Any repair, disassembly must be carried out by registered technical people. Or else, it may lead fire or fault.

! Must use the specified gas pipe.

! Do not put any spray container nearby the hob. It may lead fire.

! Any easy-burned item like clothes, newspaper, coal oil, can not be put nearby the hob.

It may lead fire.

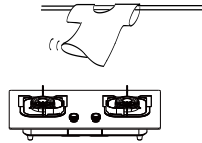

! Do not use coal oil, gas oil, or other easy-burning and explosive product nearby the hob.

It may lead fire.

ATTENTION

! There should be space of at least 400mm height between the hob bottom and cupboard. And the space can not be sealed, with hole of diameter not less than 0.2 sq meter.

! There should be space between hob and items nearby. (not less than 150mm from the wall, 1mm from above)

! Gas container can not be put right below the hob. Gas pipe not more than 2 meters.

! The hob should be kept more than 1 meter away from the gas container. Gas pipe can not reach other part of the hob.

! To ensure the burner and trivet are put in the right place before using the hob.

! Keep the kitchen in ventilated situation. But do not let strong wind to below the burner directly.

! Do not touch the trivet and burner immediately after using it, because they're very hot.

! Turn the knob to OFF and turn off the gas valve after using. Remember to turn off the gas brake when you go out or go to sleep.

ADVICE

Check whether the gas pipe are in a good situation sometimes. The pipe should be changed for every two years.

2. PARTS IDENTIFICATION

1.PARTS IDENTIFICATION

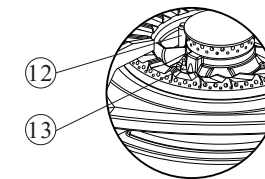
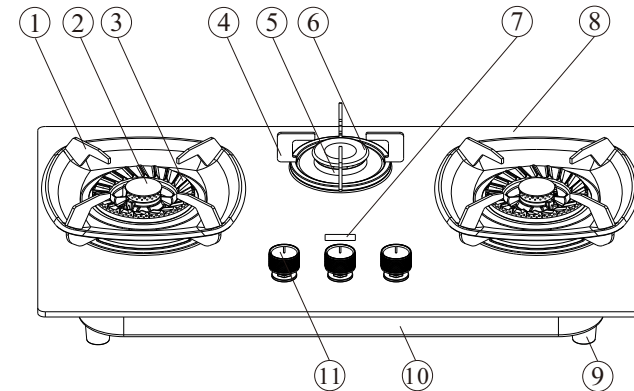

1. primary grate
2. inner burner cap
3. outer ring cap
4. auxiliary grate
5. simmer burner base
6. simmer burner cap
7. timer
8. glass panel
9. cooktop feet
10. base pan
11. knob
- 12.ignition electrode
- 13.thermocouple

Remark: above is the built-in hob structure and part identification. Other type of hob can refer to above picture.

3. INSTALLATION

1. Open holes in the cupboard:

Open holes in the cupboard with the instruction paper in the package. (see picture 3)

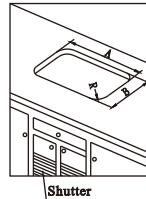

picture 3

2. Install the gas pipe

A. If to use plastic tube: put in the airproof caution, connect the tube and hob connector, fasten the clip. (see picture 4)

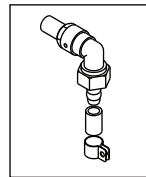

picture 4

B. If to use metal tube: put in the airproof caution, fasten the nuts on the connection. (See picture 5)

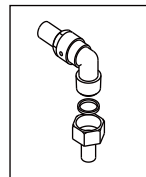

picture 5

3. Put the hob in the right hole on the cupboard, check whether it's installed in a balance.

The bottom of top plate should be stuck with seal packing.

4. check leakage: turn on the gas valve. check whether with soap water there's leakage in the connection. If any leakage, it needs to be reinstalled.(there'll be air bubble for leakage).

4. DIRECTION FOR USE

Ignition safety hob have flame failure protect device. When accident flame failure occurs by wind or spilled liquid, the flame failure protect device will shut the gas supply automatically.

1.Insert battery properly into battery case located at bottom of hob.

2.Turn on the gas valve.

3.Turn the knob left until it reaches the full on position (about 90 degree anti-clockwise).

Having heard the sound of continuous sparks, simultaneously the burner will be ignited.

Keep pushing the knob for 5-8 seconds before taking your hand.

4.You can choose five different fame by turning the hob.

5.Turn the hob to OFF by clockwise. After continuous sound, the gas supply will be cut-off, and flame out.

NOTE:

1. For the newly installed hob or hob not used for some time, it may fail to ignite at first time, because there's air in the tube. You can repeat until the air is exhausted out, then it can work.

2. If there's yellowish flame or uneven flame, adjust the damper at the bottom to get a normal flame.

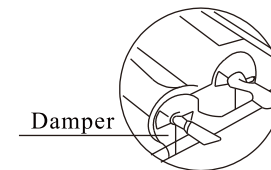

picture 6

5. PRODUCT DIMENSIONS

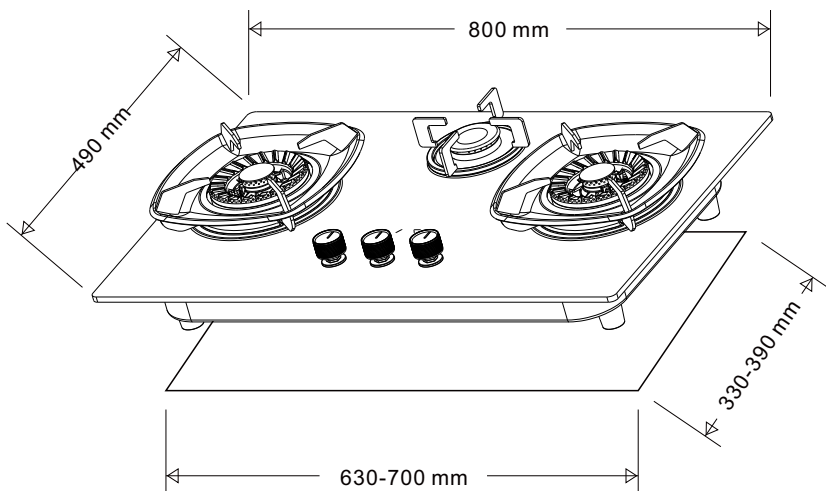

6. CLEANING AND MAINTENANCE

To ensure the hob can be used properly, clearance and maintenance are necessary. Keep the holes of the burner caps and the gas flow clear of obstructions.

Keep the electrodes and thermocouples clean and clear of debris.

Before cleaning and maintenance, shut off the gas supply and allow all parts to cool down.

Wash the burner caps, burners, electrodes, thermocouples, and trivets with mild detergent when they become dirty. Then, put them back in their proper positions.

Use a steel wire to clear any dirt from the burner cap.

When the top plate becomes dirty, never use any sharp or hard brushes; instead, use only a sponge brush with mild detergent to clean it.

Check the gas tube regularly, and replace the gas tube every two years.

7. TROUBLE-SHOOTING GUIDE

Trouble	Cause	Remedy	
Burners can not be ignited.	Gas supply is not opened	Turn on the gas	○
	Gas type is bent or crushed.	Straighten or changing the tube	○
	Short of gas supply	Replace it	○
	Air remains in the gas piping	Repeat igniting operation until all air in the piping is purged out.	○
	Electrode not in right position	Adjust it's position	△
	Small spark when ignition operation	Clear the Electrode	○
	Out off battery	Replace or install the battery	○
	Electrode broken	Replace the ignition electrode	△
Flame is extinguished	Thermocouple dirty, broken, or not in right position	Clear or replace it, or adjust it's position	△
	Electromagnet valve broken	Replace it	△
	Valve broken	Replace it	△
	Uneven flame in thermocouple	Adjust the damper	○
Gas leakage (or smell of gas)	Cracks or holes in Gas pipe	Replace it with a new one	△
	The main flame of burners is not ignited	Ignite again after the gas is clear in the air.	○
	Gas valve is not well sealed	Replace gas valve	△
	Sealing packing for gasvalve is broken	Replace the sealing packing.	○
Flame not regular	Burner cap not in proper position	Put it to proper position	○
Weak flame	Gas pressure not enough	Check the gas flow	△
Flame easy to fall	Damper hole is too big	Adapt the damper	○
Long and yellow flame	Damper hole is too small	Adapt the damper	○
Uneven flame	Hole for burner cap is stuff	Clear the hole	○

Remark: Trouble with mark “○” can be solved by final users. Trouble with “△” must be repaired by technical people. If final user can not solve problem according to above guide, call our after-sale service.